

SEES 503 SUSTAINABLE WATER RESOURCES

A decorative graphic consisting of overlapping colored squares (red, blue, green, yellow) and a vertical black line.

HYDROELECTRIC POWER

Assist. Prof. Dr. Bertuğ Akıntuğ

Civil Engineering Program
Middle East Technical University
Northern Cyprus Campus

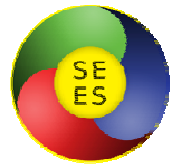

Overview

- Characteristics of Electrical Power Plants

- Terminology

- Hydroelectric Power Plants
 - Run-of-River Plants
 - Storage Plants
 - Pumped-Storage Plants

- Components of Hydroelectric Power Plants

- Availability of Hydroelectric Power and Energy
 - Flow Duration Method
 - Sequential Streamflow Routing Method

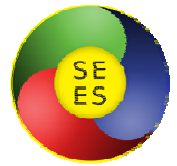

Characteristics of Electric Power Plants

- Electricity is commonly generated in
 - Hydropower Plants,
 - Thermal Plants, and
 - Nuclear Plants.
- *Hydropower plants* generate electricity by water turbines which operates by means of falling water.
- *Thermal plants* generate electricity by steam turbines, which require fossil fuel (coal, oil, or natural gas).
- *Nuclear power plants* use an atomic fuel like uranium, thorium, and plutonium.
- Alternative sources:
 - Wind energy,
 - Solar energy, and
 - Wave energy.

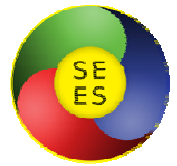

Characteristics of Electric Power Plants

Hydropower Plants

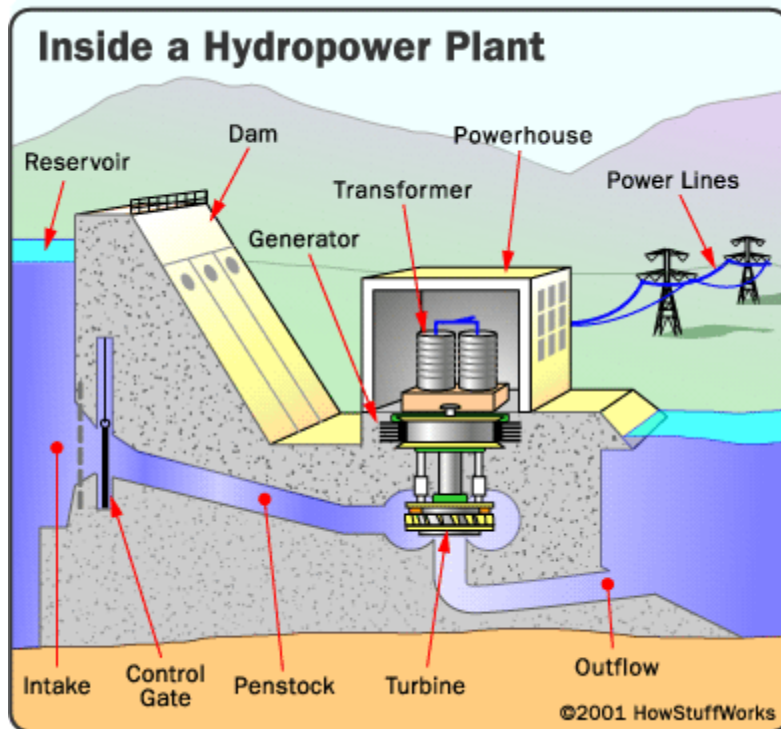

<http://science.howstuffworks.com/environmental/energy/hydropower-plant1.htm>

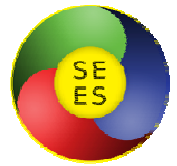

Characteristics of Electric Power Plants

Hydropower Plants

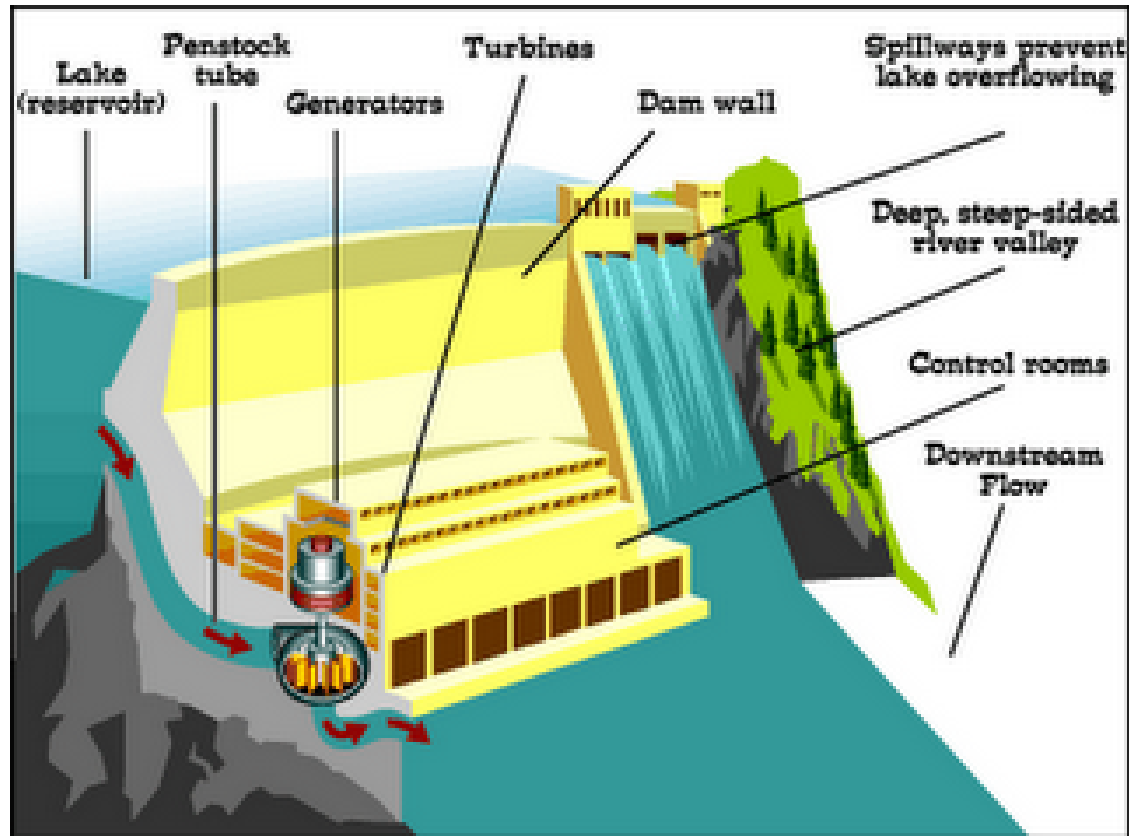

Source: <http://gilani-electricalengineering.blogspot.com/>

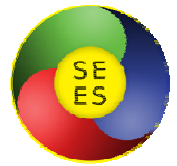

Characteristics of Electric Power Plants

Hydropower Plants

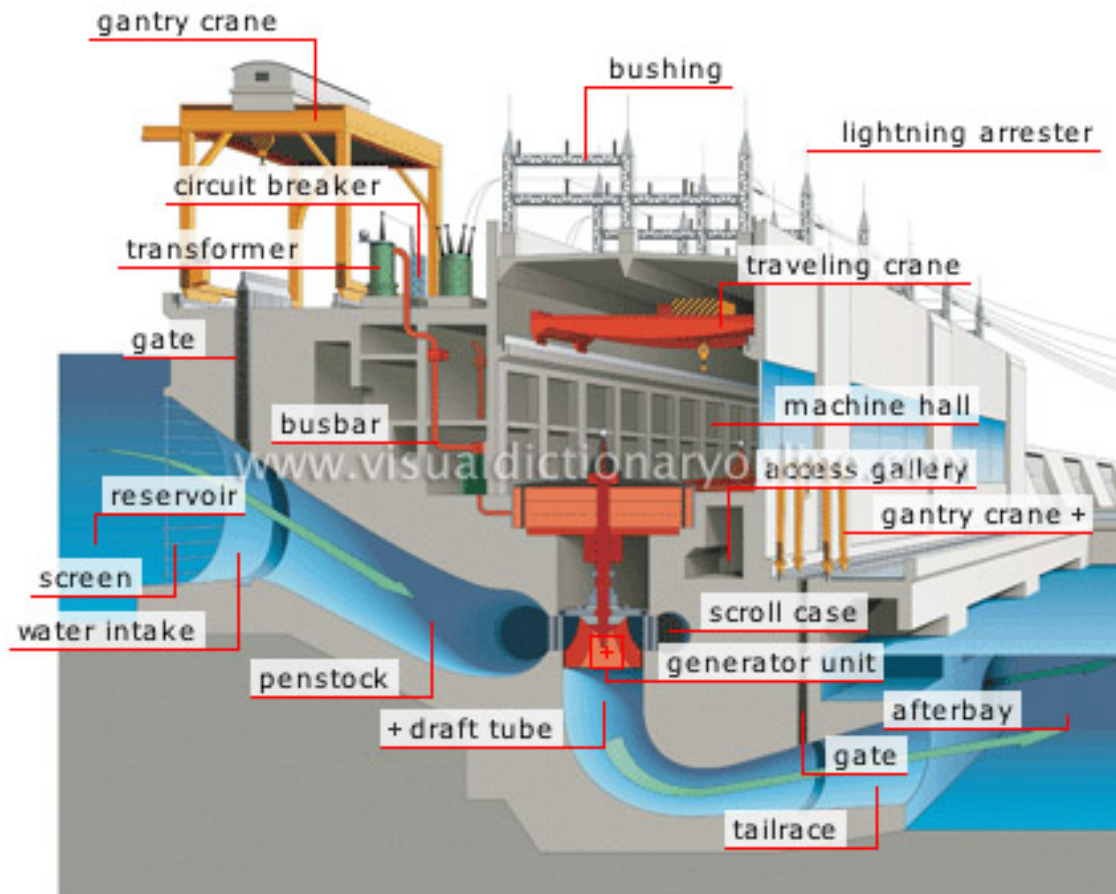

Source: <http://blog.toolanddieing.com/2009/07/27/hydropower-demand-could-benefit-manufacturers/>

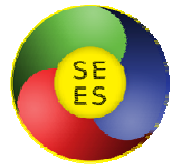

Characteristics of Electric Power Plants

Thermal Power Plants

- The process of use of fuel converts 30 to 40% of energy content of the fuel to electrical energy.
- Operational scheme of **thermal power plant**:

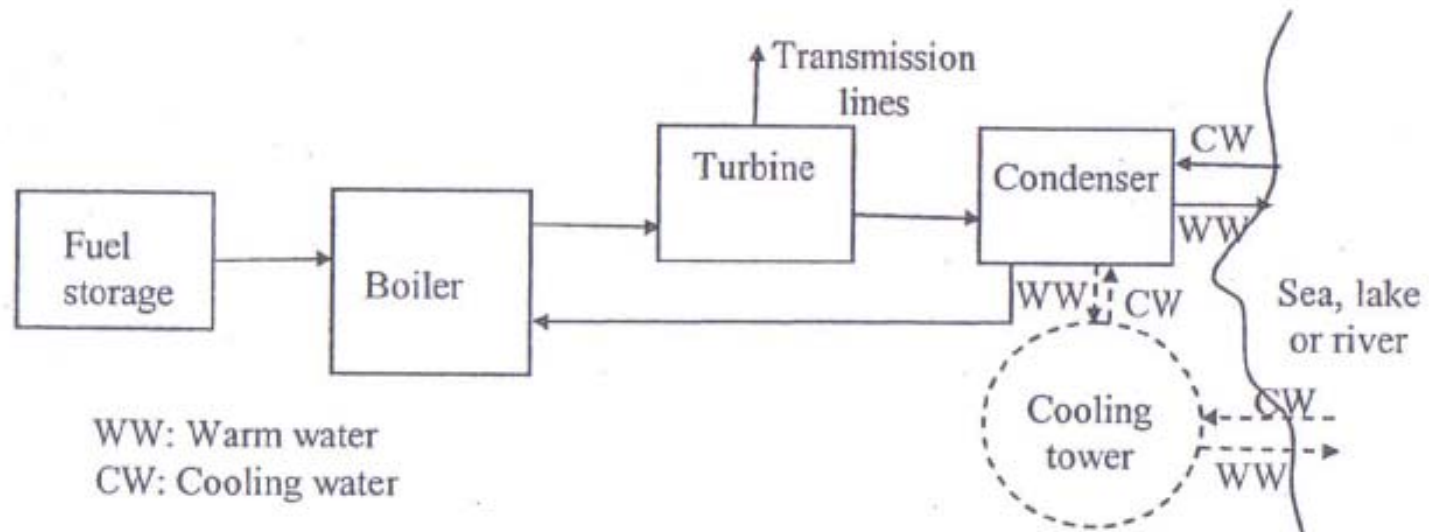
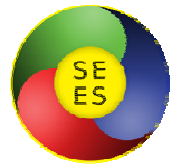
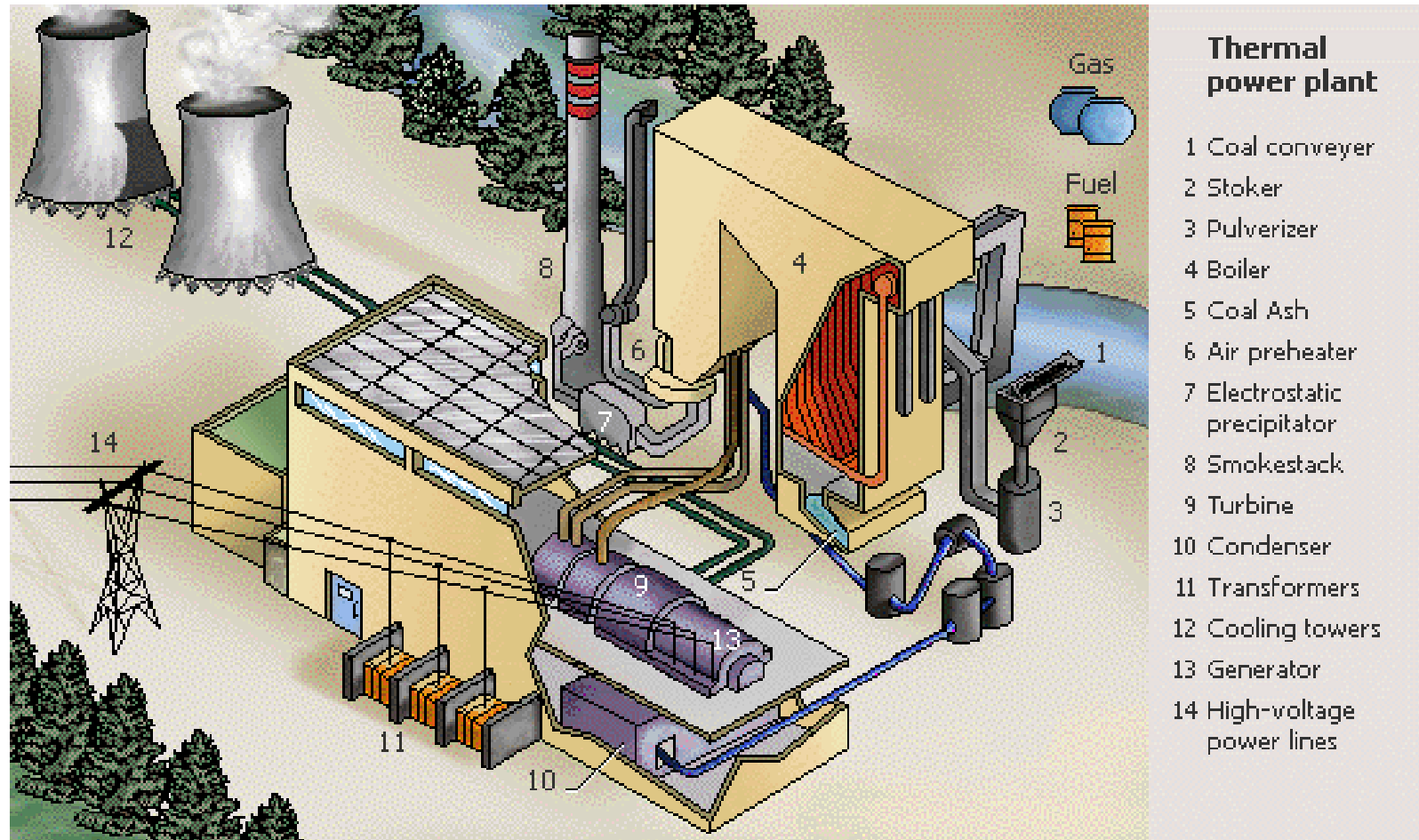

Figure 12.1 Operational scheme of a thermal power plant.



Characteristics of Electric Power Plants

Thermal Power Plants



Source: http://www.emt-india.net/process/power_plants/ThermalPowerPlants.htm

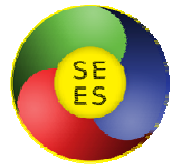

Characteristics of Electric Power Plants

Thermal Power Plants



Source: http://en.wikiversity.org/wiki/Power_Generation-Steam_Power

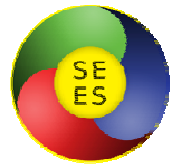

Characteristics of Electric Power Plants

- **Initial cost** of a hydroelectric plant is normally higher than that of a thermal plant producing almost the same amount of power.
- **The maintenance and repair costs** of a thermal plant are much higher than for a hydroelectric plant.
- Thermal plant needs one month of maintenance each year.
- Operation costs of thermal plant is also high because of high cost of fuel.
- The cost of hydro energy is approximately
 - one-fifth of the cost of energy generated by fossil, and
 - one-tenth of the cost of energy generated by nuclear plants.

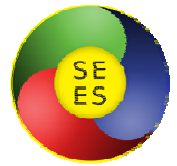

Characteristics of Electric Power Plants

■ *Hydroelectric plants*

- put in operation in only a few minutes.
- relatively high efficiency (80 to 90%).
- lifetime is about 75 years.
- non-pollutant.

■ *Thermal plants*

- needs a few hours for their startup.
- lifetime is about 25 years.
- may lead to environmental pollution if any air-pollution-control systems and cooling towers are not implemented.

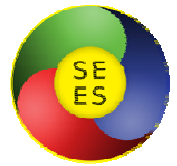

Characteristics of Electric Power Plants

- *Nuclear power plants*
 - low efficiency (i.e. about 25%)
 - annual maintenance and refueling period: two months
 - excessive safety precautions should be taken against nuclear pollution

- Optimum use of combined system:
 - The generation of base load by thermal or nuclear plants
 - The generation of peak loads by hydroelectric plants.

- Worldwide:
 - Thermal plants: ~75%
 - Hydroelectric plants: ~23%
 - Others: ~2%

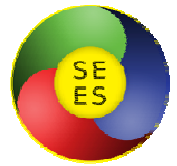

Characteristics of Electric Power Plants

- As of 2004, the annual energy generation in Turkey:
 - Hydraulic: 21%
 - Natural gas: 43%
 - Fuel oil: 9%
 - Lignite: 27%
 - Geothermal and wind: <1%
- The present total installed capacity of all power plants in Turkey : ~29000 MW

Table 12.1 Development of Electricity Generation in Turkey (DSİ, 2002).

Year	P _{ins} (MW)			E (Gwh)			L (%)
	Thermal	Hydro	Total	Thermal	Hydro	Total	
1950	390	18	408	759	31	790	-
1960	861	412	1273	1814	1001	2815	-
1970	1510	725	2235	5590	3033	8623	65
1980	2988	2131	5119	11927	11348	23275	66
1990	9536	6764	16300*	34315	23148	57543*	73
1995	11074	9863	20952*	50706	35541	86247*	71
1997	11772	10103	21890*	63480	39816	103296*	71
1998	13021	10316	23352*	68788	42234	111022*	72
1999	15556	10537	26117*	81661	34678	116440*	71
2000	16053	11171	27264*	93934	30879	124922*	74
2001	16971	11625	28660*	101608	21683	123392*	-

* Figures include geothermal and wind power.

Table 12.2 World's and Turkey's hydropower potential (DSİ, 2002).

	Gross Theoretical Hydroelectric Potential (GWh/yr)	Technically Feasible Hydroelectric Potential (GWh/yr)	Economically Feasible Hydroelectric Potential (GWh/yr)
World	40150000	14060000	8905000
Europe	3150000	1225000	800000
Turkey	433000	216000	125828

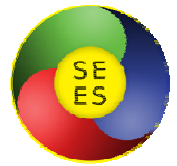

Characteristics of Electric Power Plants

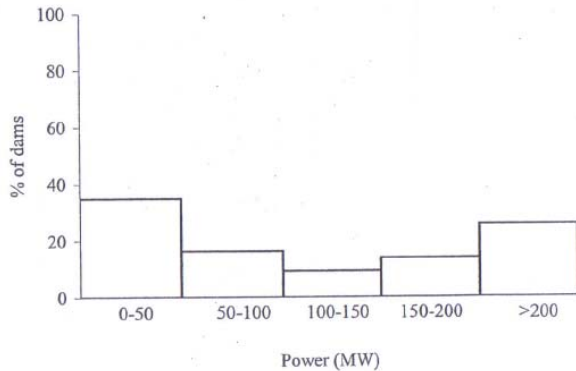

Figure 12.2 Histogram showing percent distribution of hydropower dams in Turkey according to power generation.

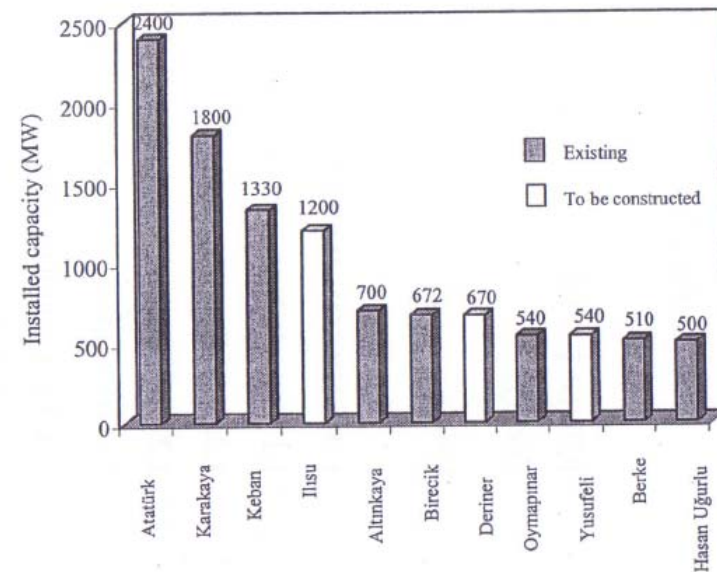

Figure 12.3 Hydropower plants in Turkey with installed capacities > 500 MW.

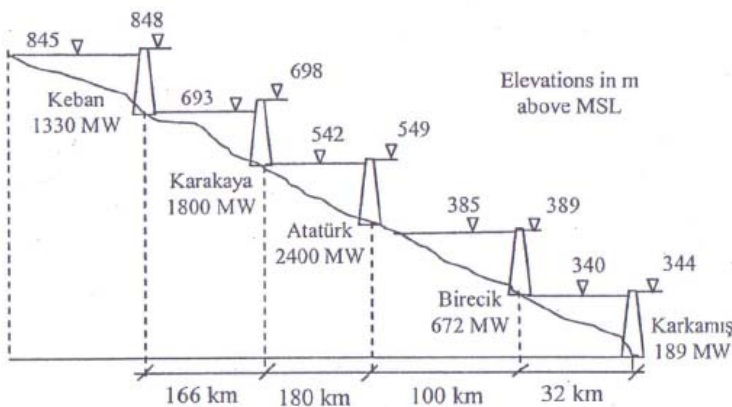
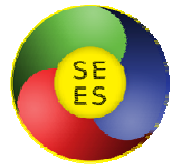

Figure 12.4 Sequential dams and hydropower plants on the Euphrates River.

Above power plants generates almost 70% of hydroelectric energy in Turkey.



Overview

- Characteristics of Electrical Power Plants

- **Terminology**

- Hydroelectric Power Plants
 - Run-of-River Plants
 - Storage Plants
 - Pumped-Storage Plants

- Components of Hydroelectric Power Plants

- Availability of Hydroelectric Power and Energy
 - Flow Duration Method
 - Sequential Streamflow Routing Method

Terminology

- **The gross head, H_g** : The vertical difference between the water surface elevations at the upstream and downstream.
- **The net effective head, H_n** : The head available for energy production.

$$H_n = H_g - (\text{head loss})$$

- **Hydraulic efficiency, e_h** : The ratio of net head to gross head.
- **Overall efficiency, e** : $e_h \times e_t \times e_g$
 e_t : efficiency of turbines
 e_g : efficiency of generators
 e is around 60-70%

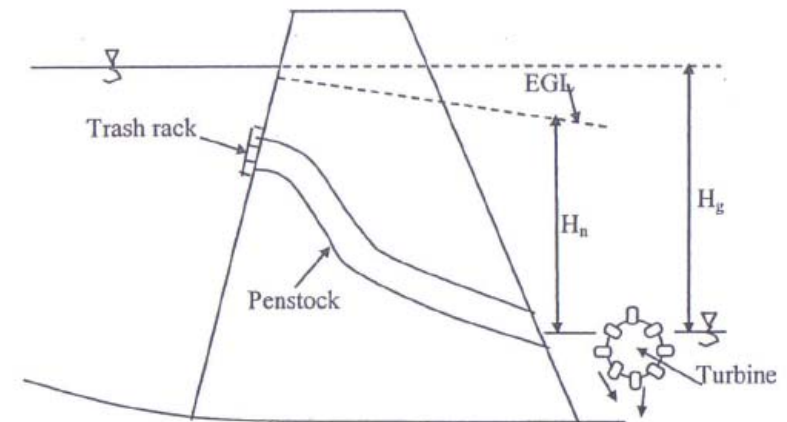
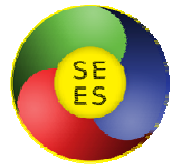

Figure 12.5 Definition of head terms for a hydropower station.



Terminology

- **The capacity (installed capacity):** The maximum power which can be developed by the generators.

- **Firm (primary) power (base load):** The power, which can be produced by a plant with no risk.
 - For a single hydroelectric plant, it corresponds to the min. availability of storage.
 - Firm energy is marketed with high price.

- **Surplus (secondary) power:** All the power available in excess of firm power.
 - Secondary power cannot be relied upon.
 - Its rate is usually less than that of firm power.
 - It can be generated ~9 to 14 hours/day.

- **Peaking load:** The power required to meet peak demands.
 - It can be generated for less than ~8 hours/day.

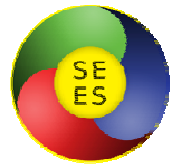

Terminology

- **Dump energy:** The energy generated that cannot be stored and is beyond instantaneous needs.
 - Usually sold at low price.

- **The load curve:** The variation of power requirement against time.
 - Evening hours → High demands
 - Midnight → Low demands
 - Weekend → Low demands
 - Winter → High demands

- **The load duration curve:** It gives the relation between the power generated and the corresponding time interval that can guarantee the generation of that power.

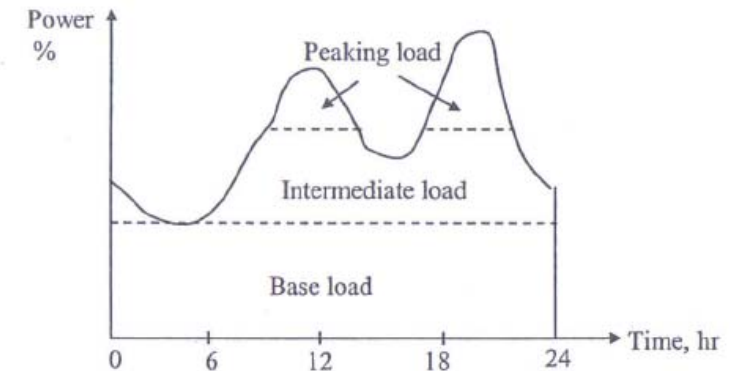

Figure 12.6 A typical load distribution curve (USACE, 1985).

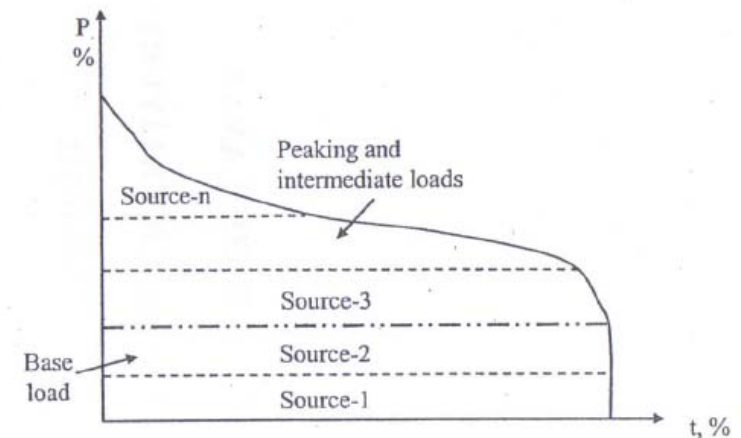
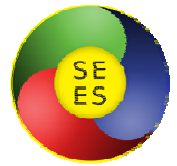
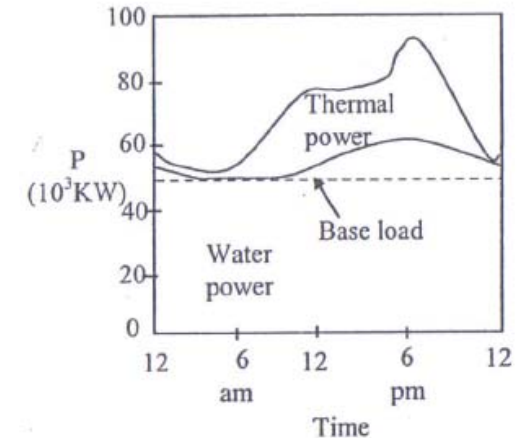

Figure 12.7 A typical load duration curve.



Terminology

- Generally hydro and thermal plants operate together in an **interconnected** power distribution system.
- Hydroelectric power plants and thermal plants are utilized in a **rotational manner** by considering
 - The quantity of water stored behind the reservoir,
 - The future hydrometeorological conditions expected, and
 - The availability of the fuel.
- In periods with **plenty of water**:
 - Hydroelectric power plants are mainly used to generate base load in order to save fuel.
- In periods with **low flow season**:
 - Thermal plants are used to produce the firm or base load.
- **Combined system** allows max. efficiency for optimum economic utilization.



a) High flow

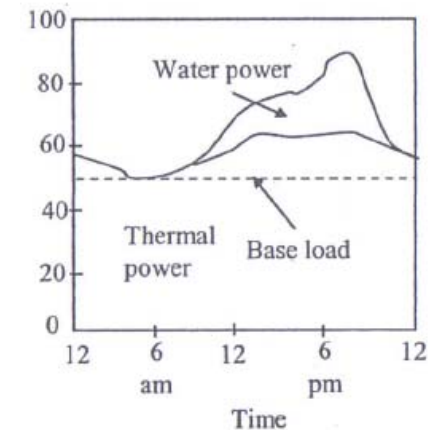

b) Low flow

Load distribution

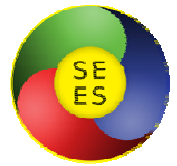

Overview

- Characteristics of Electrical Power Plants

- Terminology

- **Hydroelectric Power Plants**
 - Run-of-River Plants
 - Storage Plants
 - Pumped-Storage Plants

- Components of Hydroelectric Power Plants

- Availability of Hydroelectric Power and Energy
 - Flow Duration Method
 - Sequential Streamflow Routing Method

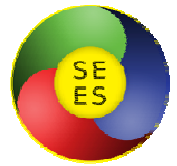

Hydroelectric Power Plants

- Hydroelectric power plants are generally classified according to their operative mode, such as
 - Run-of-river plant,
 - Storage plant, and
 - Pumped-storage plant.

Run-of-River Plants

- Uses river flow with no storage
- Productivity depends on the river regime.
- Considered as base load plants

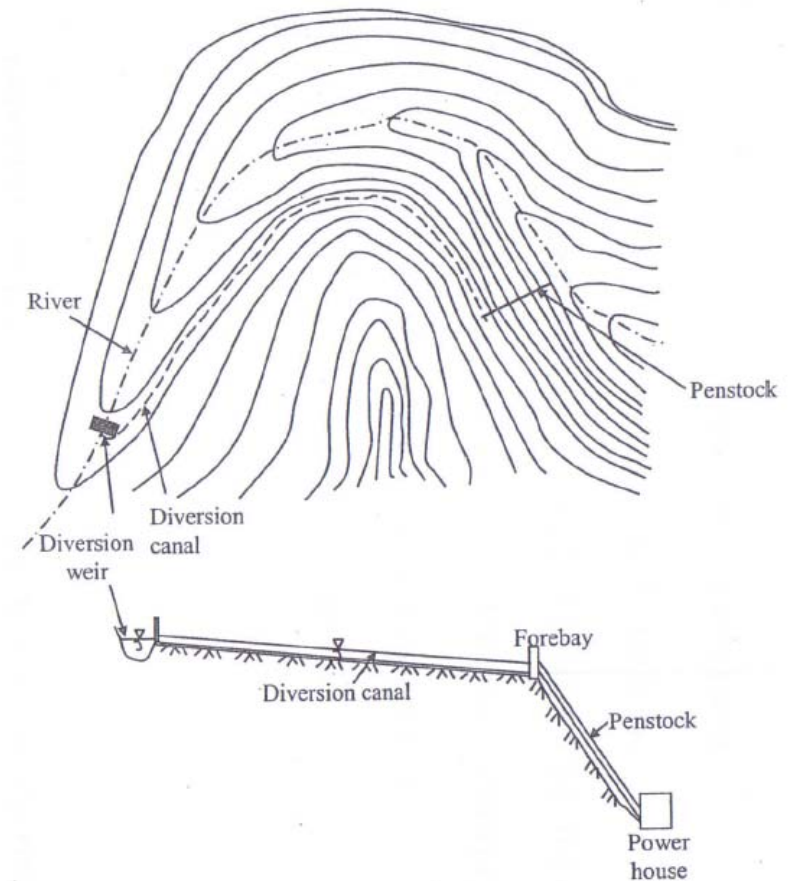

Figure 12.9 Layout and profile of a run-of-river plant.

Hydroelectric Power Plants

Run-of-River Plants (con't)

- The flow is **diverted** from the river to the lined canal (min. slope for max. head).
- **Settling basin** is used to minimize the sediment entrainment into the canal.
- Some of the plants have regulating head water pond called **forebay**.
- Forebay facilitates **daily or weekly storage** to meet intermediate or peaking loads.
- Forebay also facilitates
 - gentle approach flow conditions to intake,
 - surge reduction, and
 - sediment removal.
- A **penstock** transmits the flow to the power house.

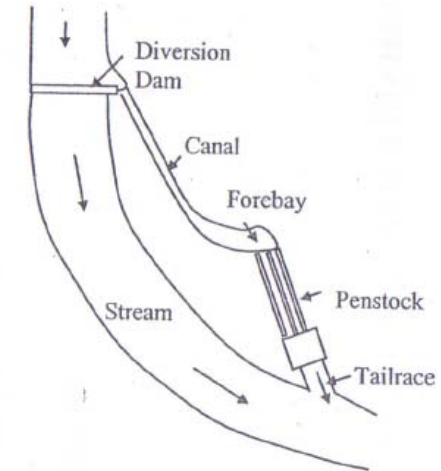

Figure 12.10 Layout of a run-of-river plant, forebay, and penstock (Linsley et al., 1992)

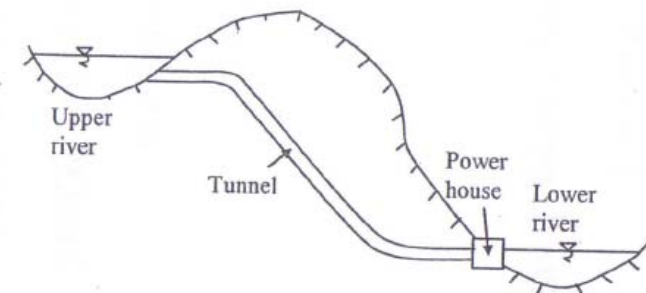
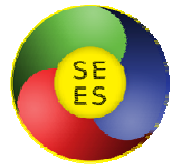
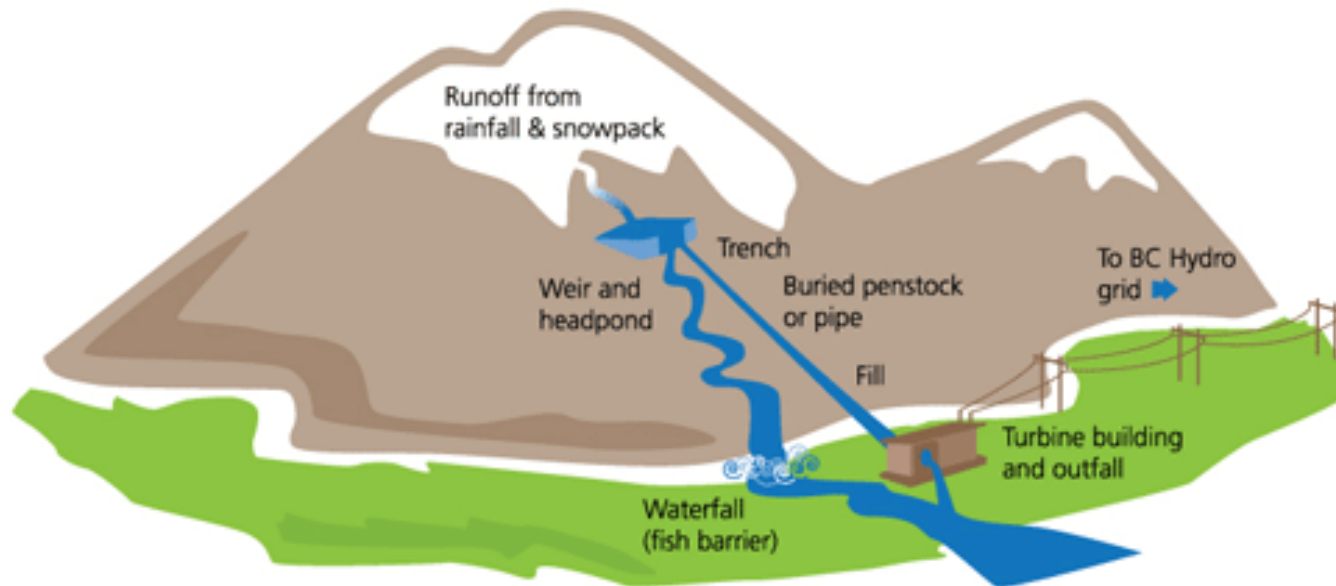

Figure 12.11 Interbasin transfer of river flow.



Hydroelectric Power Plants

Run-of-River Plants (con't)



Source: <http://jagadees.wordpress.com/2008/11/12/1000-mw-run-of-river-hydroelectric-power-plant-at-toba/>

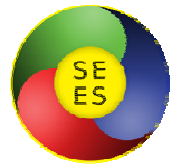

Hydroelectric Power Plants

Run-of-River Plants (con't)



Source: <http://www.pacifichydro.com.au/en-us/classroom/hydro-power.aspx>

Hydroelectric Power Plants

Run-of-River Plants (con't)



Source: <http://www.power-technology.com/contractors/powerplantequip/converteam/converteam1.html>

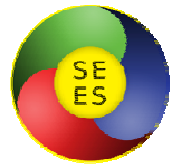

Hydroelectric Power Plants

Storage Plants

- It has a reservoir of sufficient size to develop a **firm flow substantially**.
- Depending on the size of the storage, it can meet **intermediate and peaking loads**.
- Water is withdrawn from the reservoir by means of **penstocks** to the turbines for electricity generation.
- To obtain **high head** sometimes a power house is to be constructed at a sufficiently lower elevation on the other side of a hill.
- In this case water is diverted to the penstocks by **pressure tunnels**.

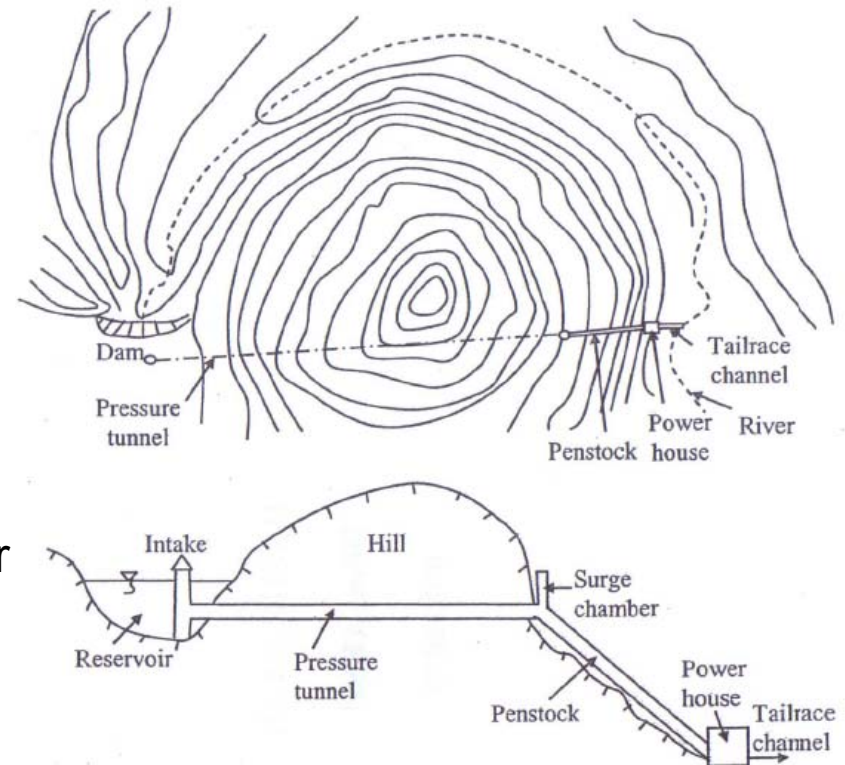
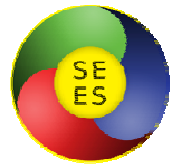

Figure 12.12 Layout and profile of a tunnel application.



Hydroelectric Power Plants

Storage Plants



<http://www.canstockphoto.com/hydropower-plant-4327963.html>

Hydroelectric Power Plants

Storage Plants



<http://pattayatoday.net/news/thailand-news/bhumibol-hydropower-plant-use-surges/>

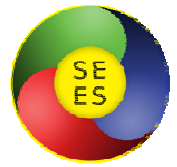

Hydroelectric Power Plants

Storage Plants



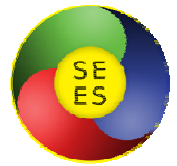

Hydroelectric Power Plants

Storage Plants



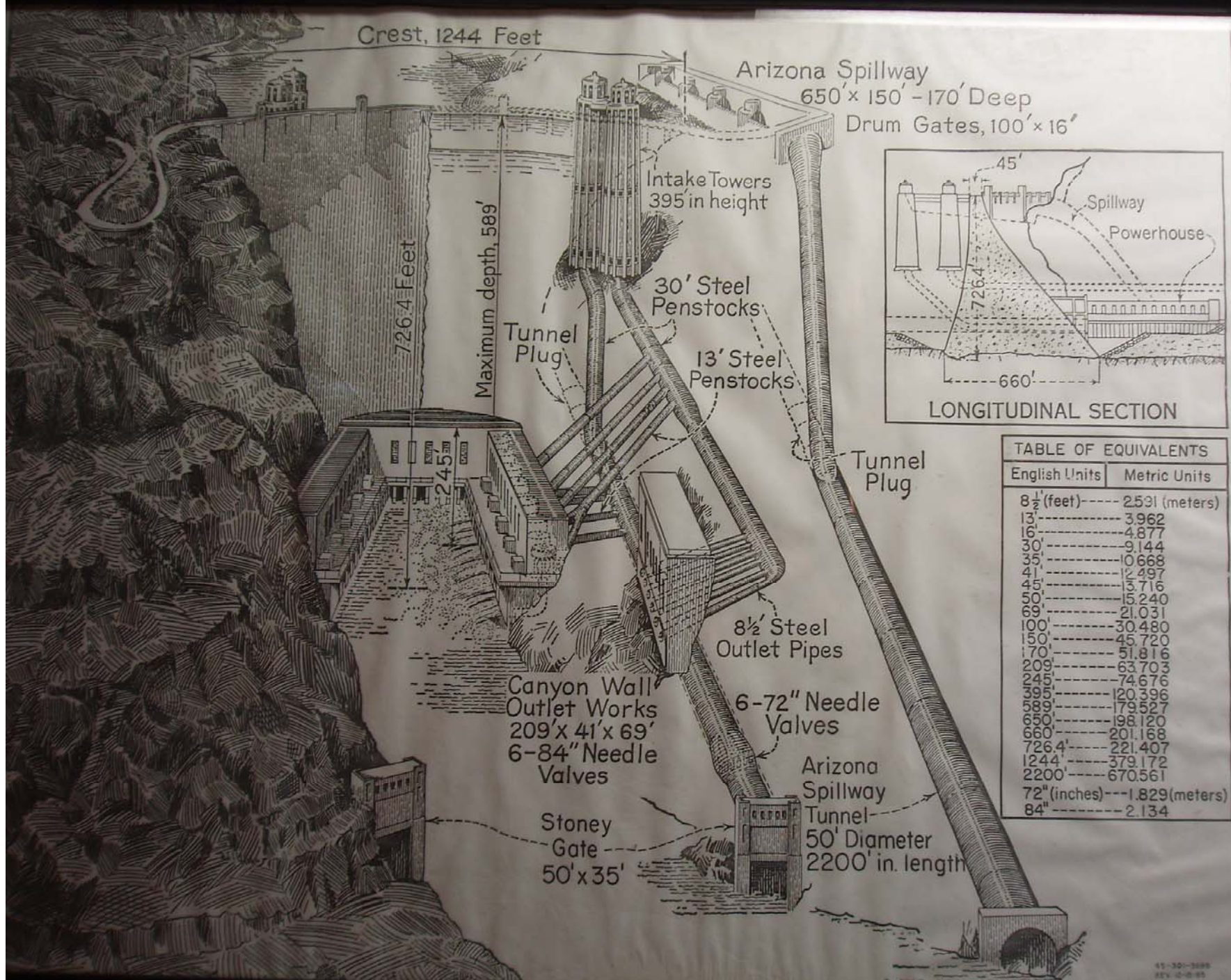
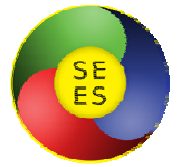

TABLE OF EQUIVALENTS	
English Units	Metric Units
8 1/2' (feet)	2.591 (meters)
13'	3.962
16'	4.877
30'	9.144
35'	10.668
41'	12.497
45'	13.716
50'	15.240
69'	21.031
100'	30.480
150'	45.720
170'	51.816
209'	63.703
245'	74.676
395'	120.396
589'	179.527
650'	198.120
660'	201.168
726.4'	221.407
1244'	379.172
2200'	670.561
72" (inches)	1.829 (meters)
84"	2.134



Hydroelectric Power Plants

Storage Plants



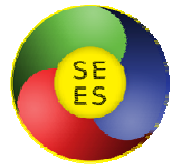

Hydroelectric Power Plants

Pumped-Storage Plants

- A pumped-storage plant incorporates a headwater and a tailwater pond jointly by a penstock and a reversible pump-turbine.
- During low demand hours:
 - The hydraulic machine pumps water from the tailwater pond to the headwater pond using surplus power generated by a fuel-fired plant in the power system with relatively low cost.
- During peak hours:
 - Water falls from the headwater pond by means of a penstock and passes through the turbine to generate electricity.
- Overall efficiency is ~70%.
- A reversible pump-turbine may operate up to ~300 m of heads with high efficiency.

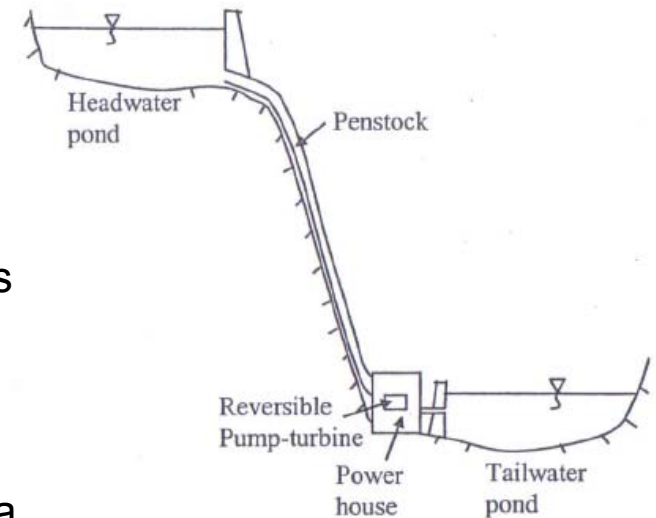
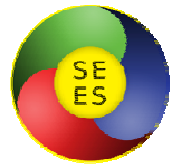

Figure 12.13 A typical pumped-storage plant.



Overview

- Characteristics of Electrical Power Plants

- Terminology

- Hydroelectric Power Plants
 - Run-of-River Plants
 - Storage Plants
 - Pumped-Storage Plants

- **Components of Hydroelectric Power Plants**

- Availability of Hydroelectric Power and Energy
 - Flow Duration Method
 - Sequential Streamflow Routing Method

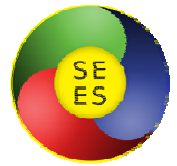

Components of Hydroelectric Power Plants

- **Dam**: to create head.
- **Water intake**: to take water and convert it to the penstock.
- **Penstock**: to take water with a high velocity to rotate **turbines**.
 - Water-hammer problem in the penstock.
- **Surge tank**: to absorb water-hammer pressure.
- **Powerhouse**
 - Substructure: electrical and mechanical instruments.
 - Superstructure: the structural elements to protect and house the operating equipment.
- **Tailrace**: the channel at the downstream of the powerhouse, which receives water from the turbines.
- **Transformers and transmission lines**: to transmit electricity to consumers.

Bottom Outlets of Hoover Dam

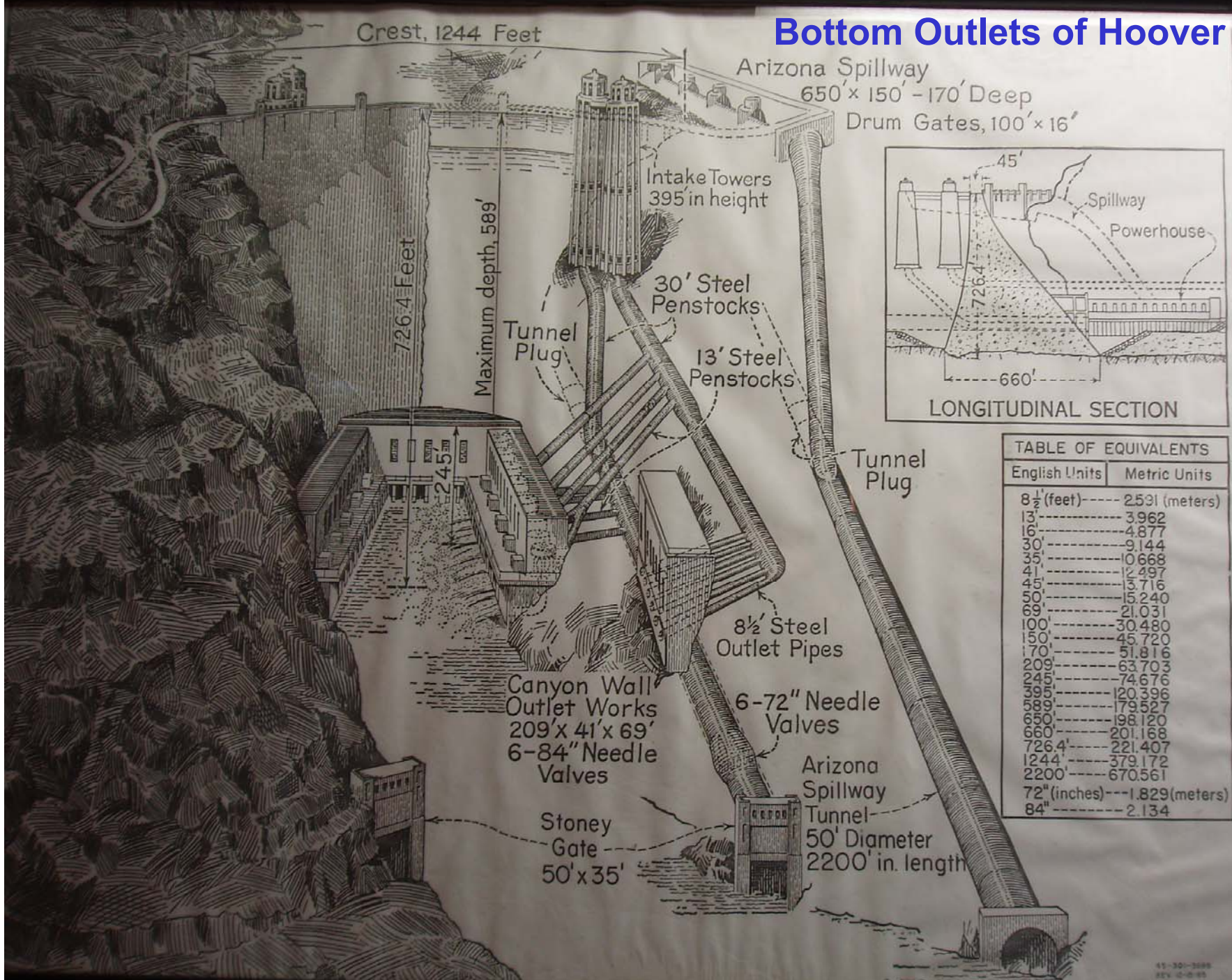

Crest, 1244 Feet

Arizona Spillway
650' x 150' - 170' Deep
Drum Gates, 100' x 16'

Intake Towers
395' in height

726.4 Feet

Maximum depth, 589'

30' Steel Penstocks

Tunnel Plug

13' Steel Penstocks

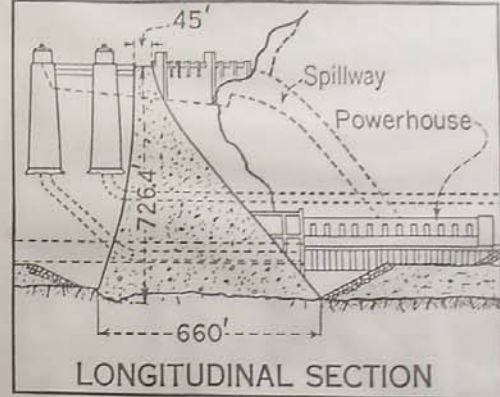

LONGITUDINAL SECTION

Tunnel Plug

8½ Steel Outlet Pipes

Canyon Wall Outlet Works
209' x 41' x 69'
6-84" Needle Valves

6-72" Needle Valves

Arizona Spillway Tunnel
50' Diameter
2200' in. length

Stoney Gate
50' x 35'

TABLE OF EQUIVALENTS	
English Units	Metric Units
8½ (feet)	2.591 (meters)
13	3.962
16	4.877
30	9.144
35	10.668
41	12.497
45	13.716
50	15.240
69	21.031
100	30.480
150	45.720
170	51.816
209	63.703
245	74.676
395	120.396
589	179.527
650	198.120
660	201.168
726.4	221.407
1244	379.172
2200'	670.561
72" (inches)	1.829 (meters)
84"	2.134

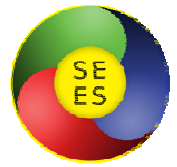

Components of Hydroelectric Power Plants

Bottom Outlets and Sluceways



Hoover Dam Inlets

Components of Hydroelectric Power Plants



Hoover Dam Inlets

Components of Hydroelectric Power Plants



Hoover Dam Penstock

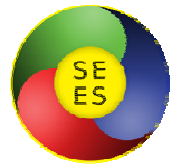

Components of Hydroelectric Power Plants

Storage Plants



<http://www.canstockphoto.com/hydropower-plant-4327963.html>

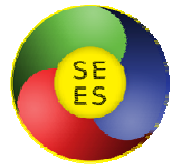

Components of Hydroelectric Power Plants

Surge Tank

N.C. Department of Environment & Natural Resources, Division of Water Resources - Instream Flow Web Page



Tuxedo Dam penstock (l), surge tank (c), and powerhouse (mid-center), Green River

Polk County, N.C.

photo courtesy of Duke Power

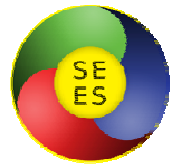

Components of Hydroelectric Power Plants

Surge Tank



http://www.flickr.com/photos/alain_quevillon/3588665603/

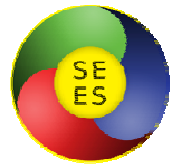

Components of Hydroelectric Power Plants

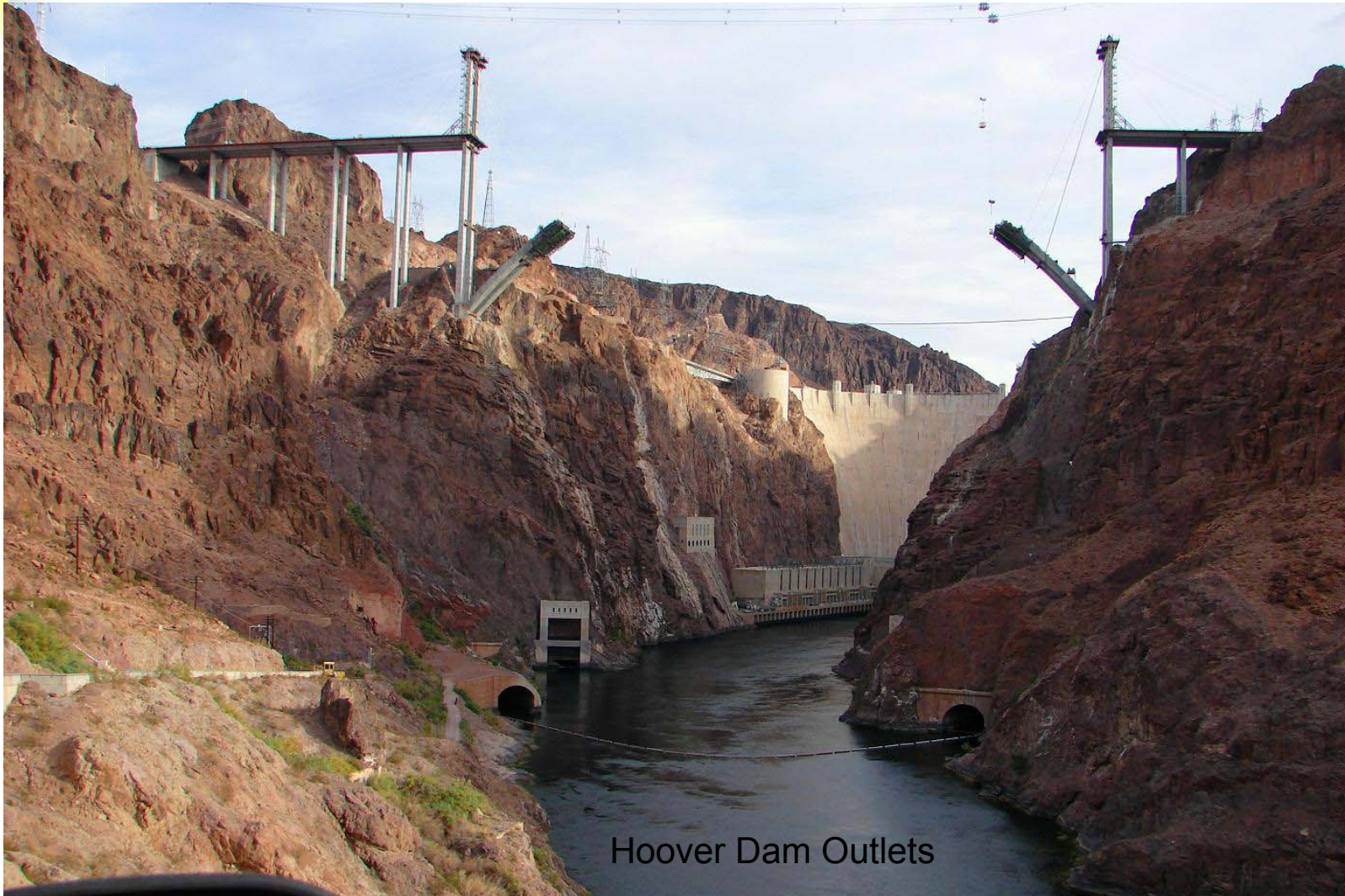

Hoover Dam Outlets

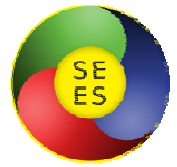

Components of Hydroelectric Power Plants

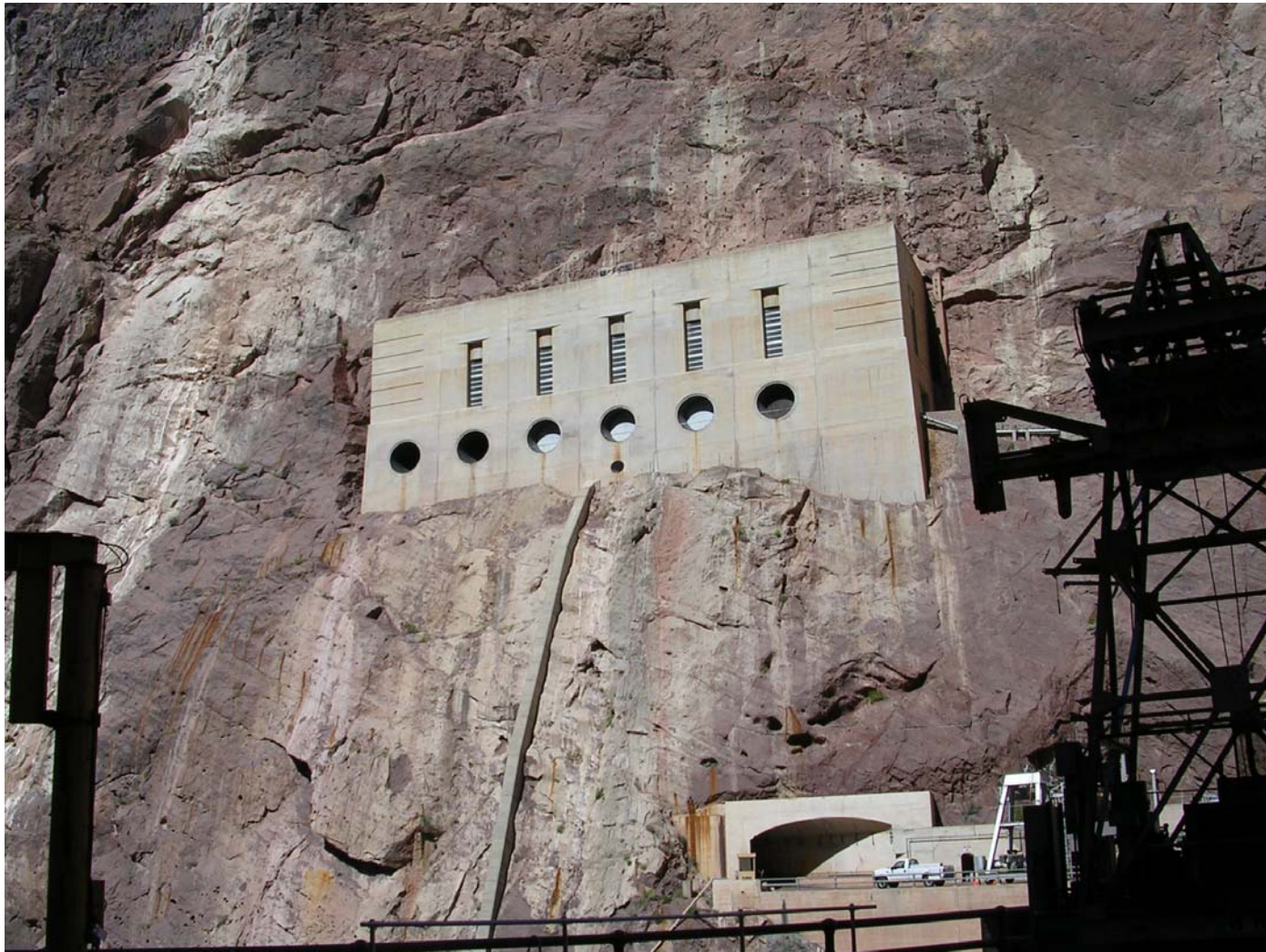

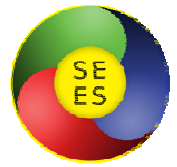

Components of Hydroelectric Power Plants



Hoover Dam Outlets





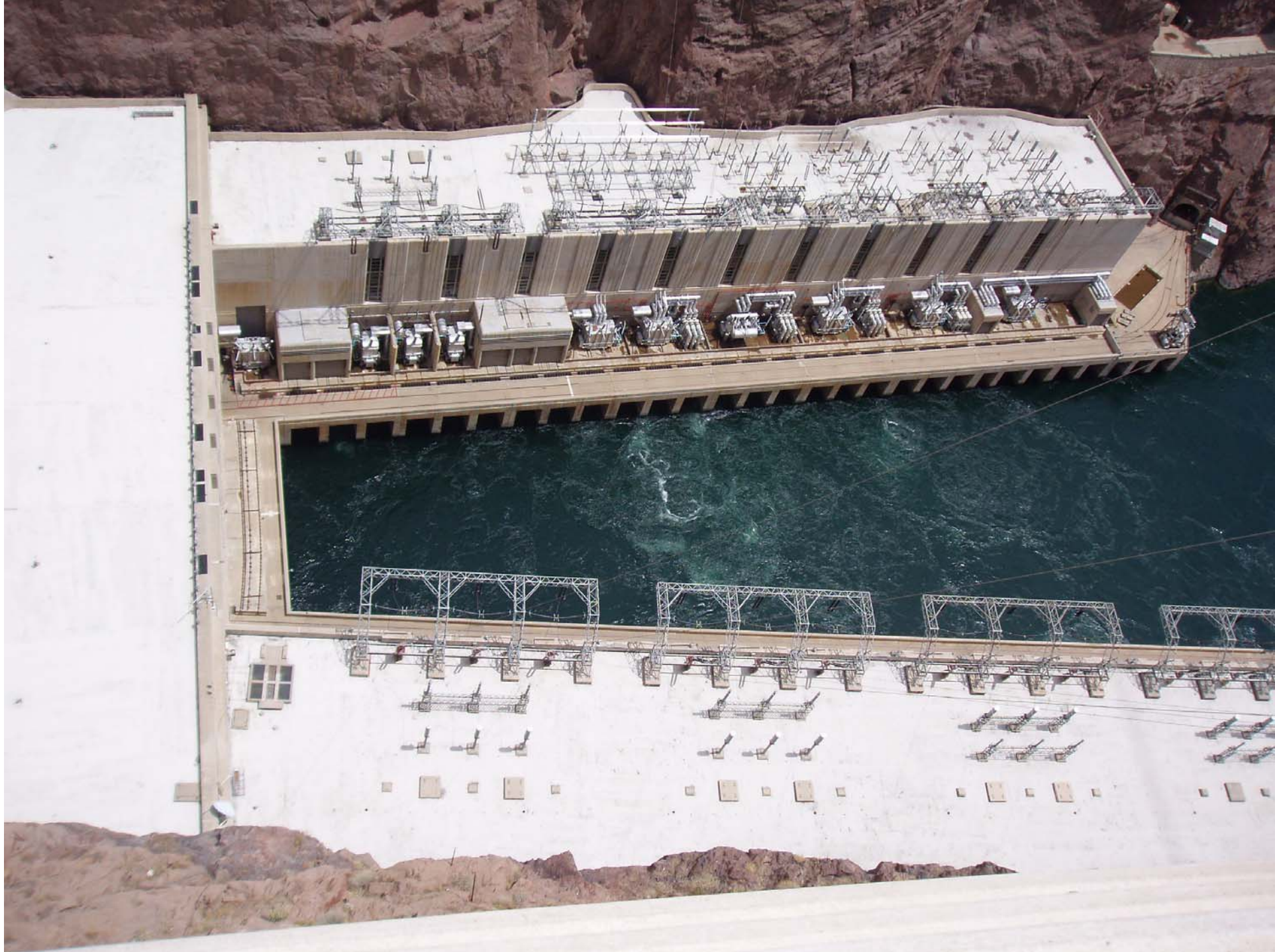

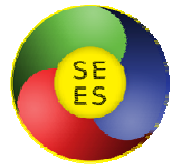

Components of Hydroelectric Power Plants



<http://www.aecom.com/What+We+Do/Energy/Hydropower+and+Dams>

Power House



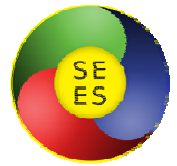

Components of Hydroelectric Power Plants

- **Dam**: to create head.
- **Water intake**: to take water and convert it to the penstock.
- **Penstock**: to take water with a high velocity to rotate **turbines**.
 - Water-hammer problem in the penstock.
- **Surge tank**: to absorb water-hammer pressure.
- **Powerhouse**
 - Substructure: electrical and mechanical instruments.
 - Superstructure: the structural elements to protect and house the operating equipment.
- **Tailrace**: the channel at the downstream of the powerhouse, which receives water from the turbines.
- **Transformers and transmission lines**: to transmit electricity to consumers.

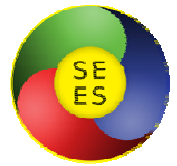

Overview

- Characteristics of Electrical Power Plants

- Terminology

- Hydroelectric Power Plants
 - Run-of-River Plants
 - Storage Plants
 - Pumped-Storage Plants

- Components of Hydroelectric Power Plants

- **Availability of Hydroelectric Power and Energy**
 - Flow Duration Method
 - Sequential Streamflow Routing Method

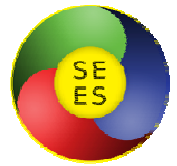

Availability of Hydroelectric Power and Energy

- **Streamflow data** are required to estimate the availability of water for power generation.
- **Flow-Duration curves** may be generated to study the variation of flow in the river but they cannot provide info about **chronological sequence of flow**.
- **Sequential streamflow routing** method is used.
- To estimate the power potential of the river or reservoir, Sequential streamflow routing method considers:
 - tailwater rating curve,
 - reservoir operation studies, and
 - downstream flow information

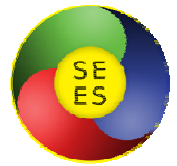

Availability of Hydroelectric Power and Energy

- Hydroelectric Power:

$$P = \gamma Q H_g e$$

- Generated Energy:

$$E = \gamma Q H_g e \Delta t$$

where P: power (kW)

γ : specific weight of water (kN/m³)

Q : discharge (m³/s)

H_g : gross head (m)

e : overall efficiency, $e = e_h e_g e_t$ (%)

E : hydroelectric energy (kWh)

Δt : time interval for power generation (hours).

- Electric energy is generally expressed in terms of its annual value ($\Delta t=8760$ hr).

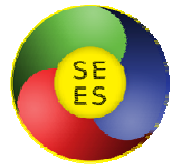

Availability of Hydroelectric Power and Energy

- The mean annual energy productions of some of the large Turkish dams are:
 - Ataturk Dam: 8.9×10^9 kWh
 - Karakaya Dam: 7.354×10^9 kWh
 - Keban Dam: 6.0×10^9 kWh
- For small hydropower projects (run-of-river projects), flow-duration curves can be converted to power-duration curves (Ex. 12.5).
- This curve then be used to estimate the energy potential of the river (Ex. 12.4)
- The **installed capacity**, P_{ins} : The maximum power that a generator can develop.

- The load factor = (Average Power) / (Max. Power)

- Average annual plant factor (L) = $E / (8760 P_{ins})$

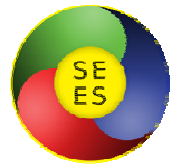

Availability of Hydroelectric Power and Energy

Flow Duration Method

- Used particularly for run-of-river projects.
- Not applicable for more than one project.
- Procedure for determining the power-duration curve and average annual energy production: Example 12.5

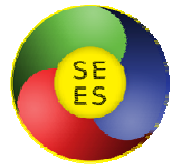

Availability of Hydroelectric Power and Energy

Sequential Streamflow Routing Method

- Computes the energy output for each time interval in the period of analysis
- The method considers the effect of reservoir operation based on the continuity equation.
- This method is repeated for various installed capacities to determine an optimum size (installed capacity) that maximizes the annual energy production.
- Procedure best suits to computer application.

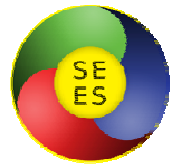

Examples

Example 12.2: The mean monthly releases from a storage reservoir for electricity generation are given below in 10^6 m^3 . There exists a hydropower station with a net head of 29.1 m. Taking $e_n=0.95$, $e_t=0.90$, and $e_g=0.95$, determine the annual load factor.

M	J	F	M	A	M	J	J	A	S	O	N	D
Flow	14	19	21	29	46	26	19	16	11	8	11	11

Example 12.3: A hydroelectric power plant is planned for construction. The total annual flow, which can be released from the reservoir for electricity generation, is $880 \cdot 10^6 \text{ m}^3$ and is assumed to be time-invariant. Determine the annual energy production. There is only one penstock having a length and diameter of 500 m and 5 m, respectively. The Hazen-Williams coefficient is $C=95$. Take $e_g=0.90$, $e_t=0.85$, and $H_g=50 \text{ m}$.